

## Dual transil array for ESD protection

### General Description

The RSTD2Z25V is a dual monolithic voltage suppressor designed to protect components which are connected to data and transmission lines against ESD. It clamps the voltage just above the logic level supply for positive transients, and to a diode drop below ground for negative transients. It can also work as bidirectional suppressor by connecting only pin1 and 2.

### Applications

- Computers
- Printers
- Communication systems

It is particularly recommended for the RS232 I/O port protection where the line interface withstands only with 2kV ESD surges.

### Features

- 2 Unidirectional Transil functions
- Low leakage current:  $I_R \max < 20 \mu A$  at VBR
- 3 00W peak pulse power(8/20  $\mu s$ )
- High ESD protection level: up to 25 kV
- We declare that the material of product compliance with RoHS requirements.

### Benefits

- High ESD protection level
- up to 25 kV. High integration.
- Suitable for high density boards.

### Complies with the following standards

IEC61000-4-2 Level 4

MIL STD 883c - Method 3015-6 Class 3

(Human Body Model)

### Absolute Ratings ( $T_{amb}=25^{\circ}C$ )

Symbol	Parameter	Value	Units
$P_{PP}$	Peak Pulse Power ( $t_p = 8/20\mu s$ )	300	W
$T_L$	Maximum lead temperature for soldering during 10s	260	$^{\circ}C$
$T_{stg}$	Storage Temperature Range	-55 to +150	$^{\circ}C$
$T_{op}$	Operating Temperature Range	-40 to +125	$^{\circ}C$
$T_j$	Maximum junction temperature	150	$^{\circ}C$
$V_{PP}$	Electrostatic discharge		
	MIL STD 883C -Method 3015-6	25	kv
	IEC61000-4-2 air discharge	16	
IEC61000-4-2 contact discharge	9		

## RSTD2Z25V

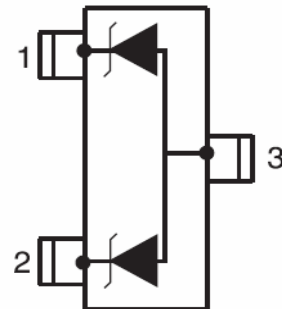

### ORDERING INFORMATION

Device	Package	Shipping
RSTD25V	SOT-23	3000/Tape & Reel

# RSTD2Z25V

## Electrical Parameter

Symbol	Parameter
$V_{RM}$	Stand-off voltage
$V_{BR}$	Breakdown voltage
$V_{CL}$	Clamping voltage
$I_{RM}$	Leakage current
$I_{PP}$	Peak pulse current
$\alpha T$	Voltage temperature coefficient
$V_F$	Forward voltage drop
C	Capacitance
$R_d$	Dynamic resistance

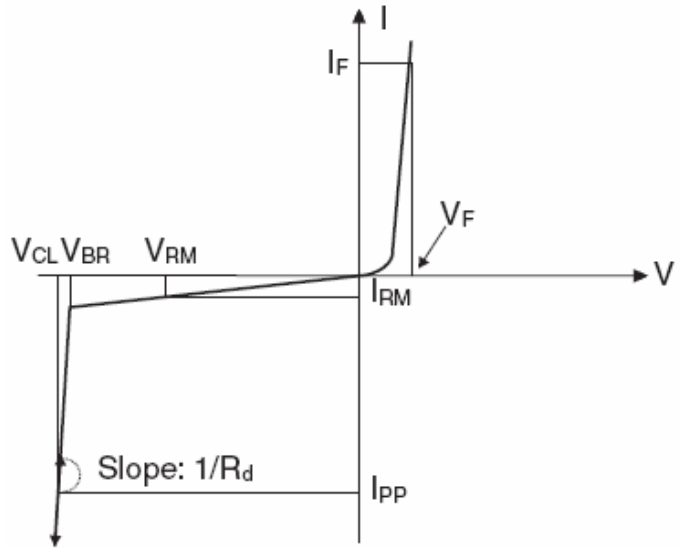

## Electrical Characteristics

Part Numbers	$V_{BR}$		$I_R$	$V_{RM}$	$I_{RM}$	$V_F$		$R_d$	$\alpha T$	C
	Min.	Max.				Max.	$I_F$			
	v	v								
RSTD2Z5V	5.0	5.9	1	3	2	1.25	200	280	5	220
RSTD2Z6V	6.0	7.2	1	5.25	20	1.25	200	350	6	140
RSTD2Z14V	14.0	15.8	1	12	5	1.25	200	650	10	90
RSTD2Z25V	25	30	1	24	1	1.2	10	1000	10	50

1. Square pulse  $I_{PP}=15A, t_p=2.5\mu s$  2.  $\Delta V_{BR}=\alpha T*(T_{amb}-25^{\circ}C)*V_{BR}(25^{\circ}C)$

## Typical Characteristics

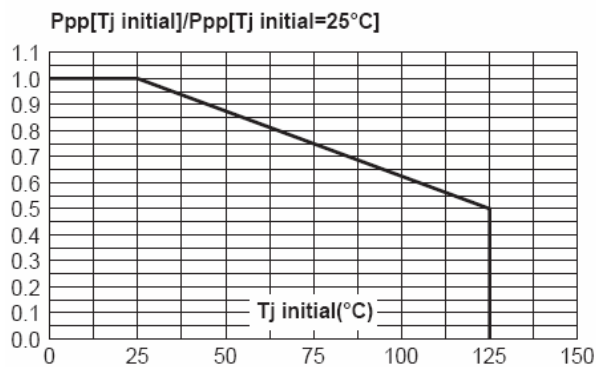

Fig1. Peak power dissipation versus Initial junction temperature

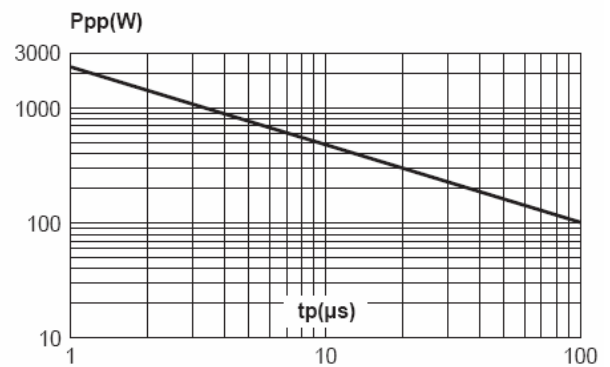
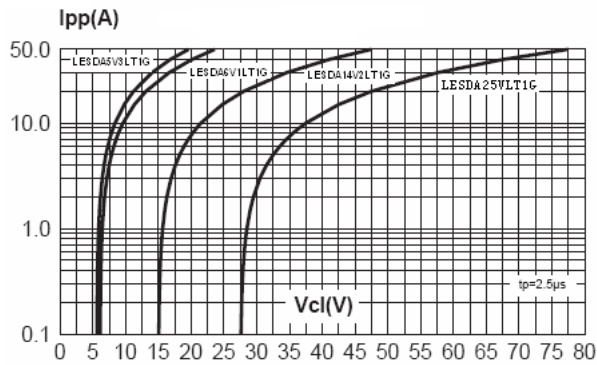
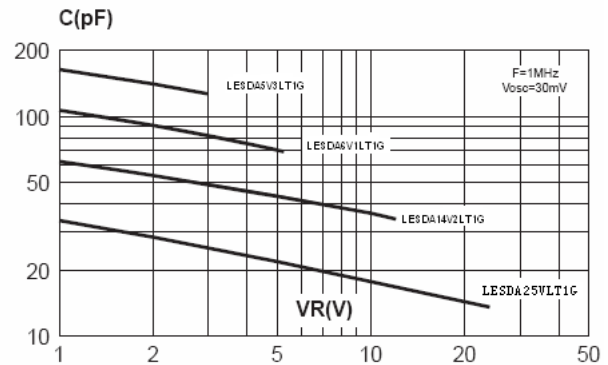

Fig2. Peak pulse power versus exponential pulse duration ( $T_j$  initial = 25°C)

# RSTD2Z25V



**Fig3. Clamping voltage versus peak pulse current ( $T_j$  initial=25°C, rectangular Waveform,  $t_p=2.5 \mu s$ )**



**Fig4. Capacitance versus reverse Applied voltage**

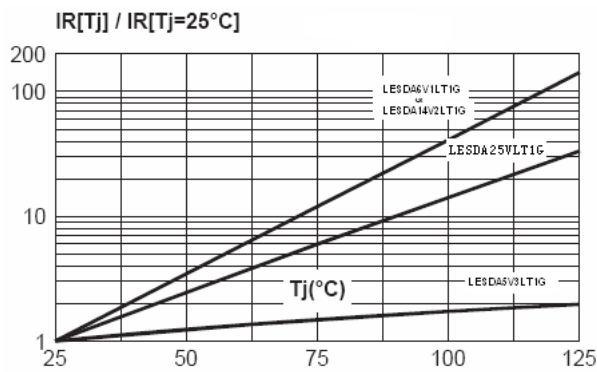

**Fig5. Relative variation of leakage current Versus junction temperature**

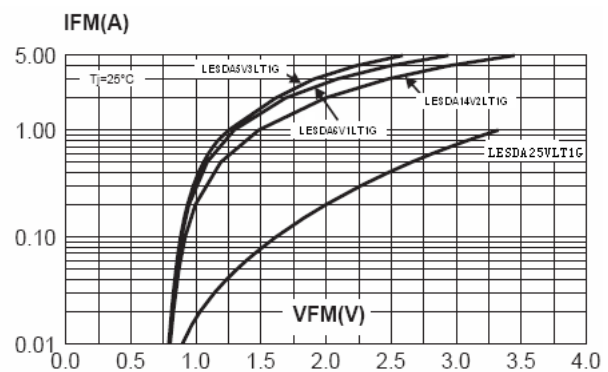

**Fig6. Peak forward voltage drop versus peak forward current**

## Application Note

Electrostatic discharge (ESD) is a major cause of failure in electronic systems. Transient Voltage Suppressors (TVS) are an ideal choice for ESD protection. They are capable of clamping the incoming transient to a low enough level such that damage to the protected semiconductor is prevented.

Surface mount TVS arrays offer the best choice for minimal lead inductance. They serve as parallel protection elements, connected between the signal line to ground. As the transient rises above the operating voltage of the device, the TVS array becomes a low impedance path diverting the transient current to ground.

The tiny SOT23 package allows design flexibility in the design of high density boards where the space saving is at a premium. This enables to shorten the routing and contributes to hardening against ESD.

# RSTD2Z25V

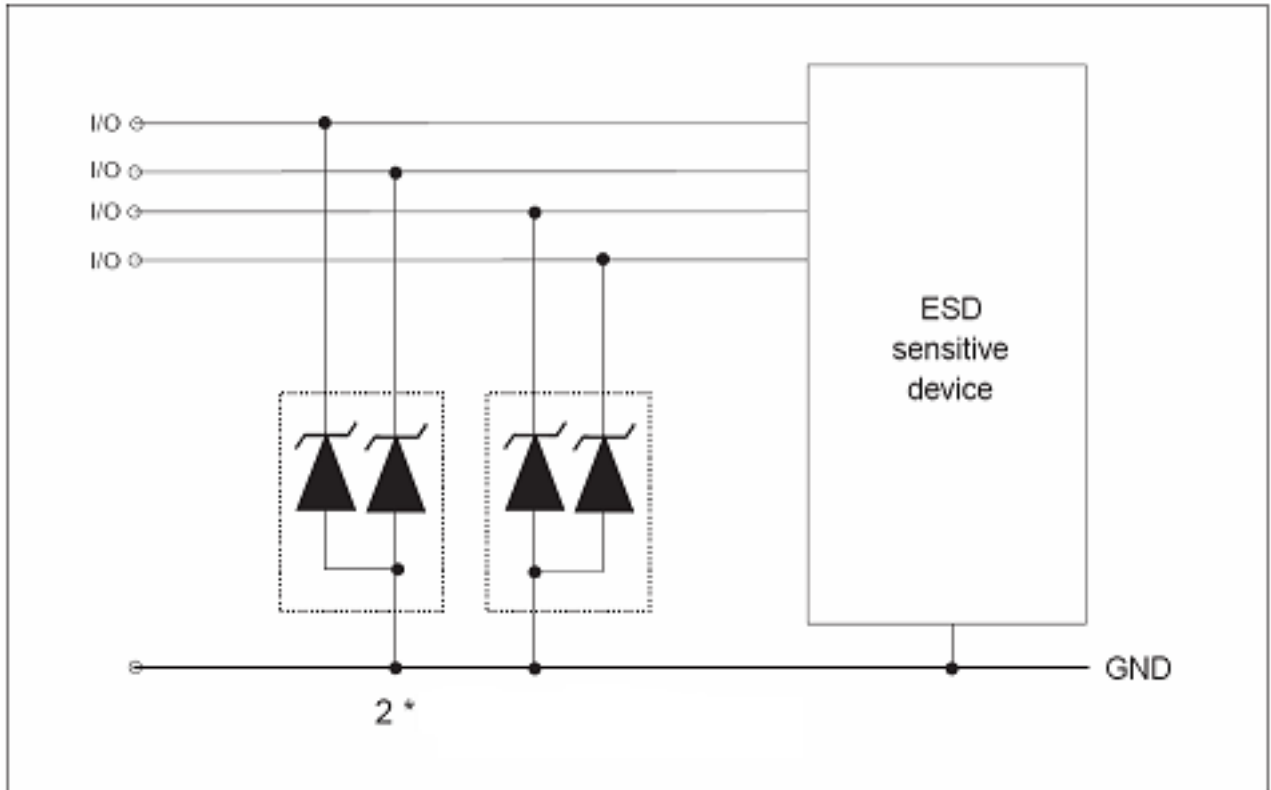

# RSTD2Z25V

## SOT-23

**NOTES:**

1. DIMENSIONING AND TOLERANCING PER ANSI Y14.5M,1982
2. CONTROLLING DIMENSION: INCH.

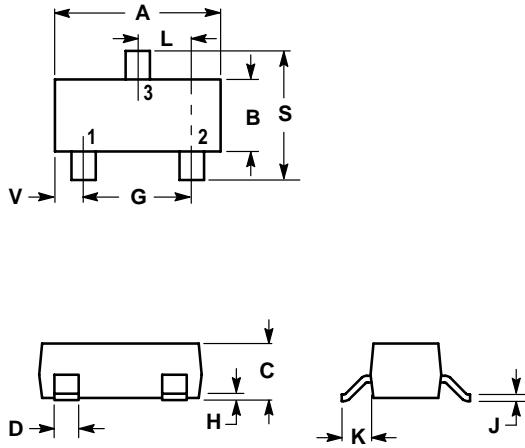

DIM	INCHES		MILLIMETERS	
	MIN	MAX	MIN	MAX
A	0.1102	0.1197	2.80	3.04
B	0.0472	0.0551	1.20	1.40
C	0.0350	0.0440	0.89	1.11
D	0.0150	0.0200	0.37	0.50
G	0.0701	0.0807	1.78	2.04
H	0.0005	0.0040	0.013	0.100
J	0.0034	0.0070	0.085	0.177
K	0.0140	0.0285	0.35	0.69
L	0.0350	0.0401	0.89	1.02
S	0.0830	0.1039	2.10	2.64
V	0.0177	0.0236	0.45	0.60

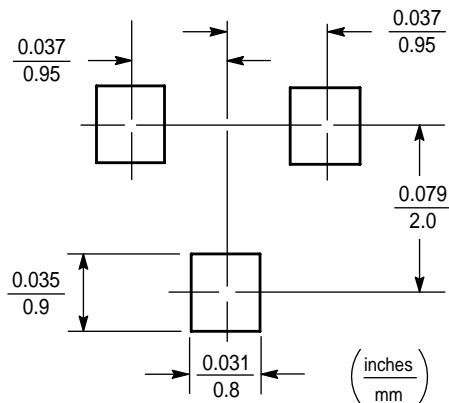

## EMBOSSED TAPE AND REEL DATA FOR DISCRETES

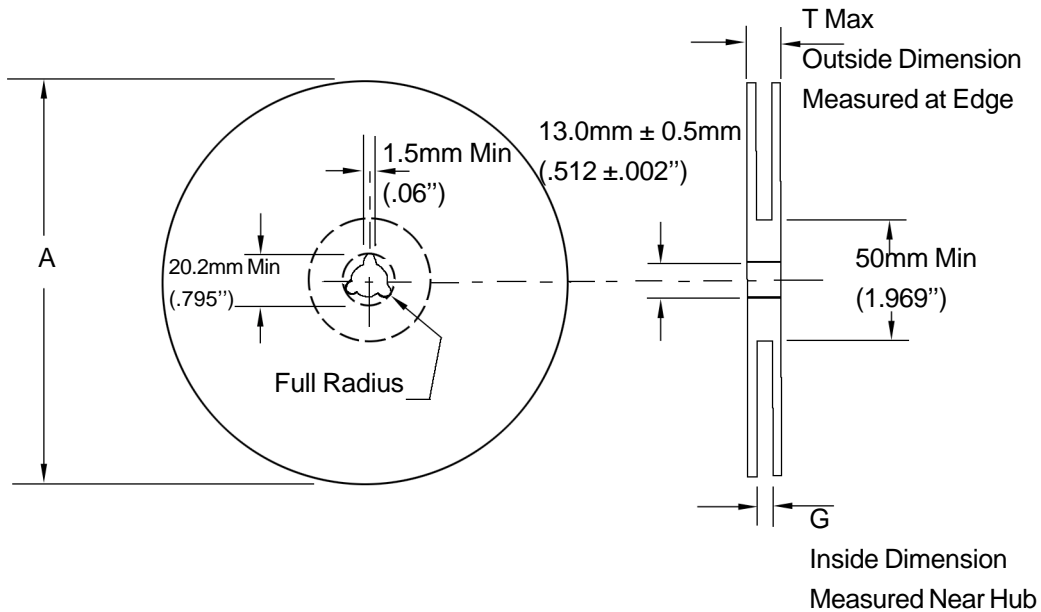

Size	A Max	G	T Max
8 mm	330mm (12.992")	8.4mm+1.5mm, -0.0 (.33"+.059", -0.00)	14.4mm (.56")

### Reel Dimensions

Metric Dimensions Govern — English are in parentheses for reference only

#### Storage Conditions

Temperature: 5 to 40 Deg.C (20 to 30 Deg. C is preferred)

Humidity: 30 to 80 RH (40 to 60 is preferred)

Recommended Period: One year after manufacturing

(This recommended period is for the soldering condition only. The characteristics and reliabilities of the products are not restricted to this limitation)

## Shipment Specification

